

# Padlocks

TESA

ASSA ABLOY



# Padlocks that shut lots of advantages



When you think of safety, think of TESA. And now we give you yet another reason for doing so: our new range of padlocks. A whole series which helps us to keep ahead of all the other trademarks because our padlocks not only meet

the most stringent requirements regarding safety, resistance and durability but they also provide you with advantages that nobody else is able to provide. Once again, TESA is a reference point in terms of security.

## Internal security

Still using a padlock with a flat key? The external appearance of a padlock is often considered to be more important than what is concealed within. That is why, although many padlocks have a robust external appearance, nobody had hitherto thought of using one of the best safety weapons existing for the inside: cylinders for flat keys! TESA has done this and provides you with padlocks which are as secure on the outside as on the inside.



## Masterkeying

Masterkeying enables the same key to be used in different padlocks, irrespective of the fact that each of them has its own key. Thus, maximum comfort and safety is obtained, because a single master key is capable of opening all the padlocks you wish. For offices, houses and companies of different sizes, masterkeying enables you to increase security by reducing the number of keys to be used, and to establish access control.



## TESA guarantees

Quality is assured when you buy TESA products. Here at TESA the very latest technology is used by a creative workforce organised within a management framework which has obtained not only the ISO 9001 quality control guarantee but also the environmental certificate ISO 14001 and which delivers an on-going commitment to the very highest of health and safety standards at work.

## Interchangeability

The only padlock in the world which is adapted to your needs. Depending on your security needs or on the goods you wish to protect, our padlocks give you the chance to choose the cylinder you prefer for your padlock and to change it when you wish. In this way you choose the degree of security you desire at any given time, because we give you the chance to choose from among the wide range of TESA cylinders.



## Electronic cylinders for access control

Access points which nobody believed could be controlled now under control. The possibility of exchanging cylinders gives a new dimension to padlocks: the chance to insert an electronic cylinder for access control in your padlock and therefore to know who has entered this access point, when and at what exact time. In this way, you can choose to integrate any access point within a comprehensive locking plan, even though the only way of locking it may be by using a padlock. Thus, you will not leave a single access point outside the security system you design.



Here are the manufacturing specifications of each of our padlocks. A range from which you will always be able to find a made-to-measure key, because they have been developed in order to provide a wide variety of performance features: ranging from padlocks which comply with the strictest safety parameters to those which offer the utmost resistance against corrosion and resistance to adverse weather conditions, to those designed to be used within an access control system.



| Padlocks / series           | Features  | Weatherproof | Masterkeying | Electronic cylinder | Key alike | Security |
|-----------------------------|---|--------------|--------------|---------------------|-----------|----------|
| Titanium series             | Weatherproof  | *****        | •            | •                   | •         | *****    |
| Titanium series             | High security double ball locking mechanism                 | ****         | •            | •                   | •         | *****    |
| Titanium series             | Strict requirements in terms of security and access control | ****         | •            | •                   | •         | *****    |
| High security series        | Security ball locking mechanism                             | ****         | •            | •                   | •         | *****    |
| High security series        | Strict requirements in terms of security and access control | ****         | •            | •                   | •         | *****    |
| Security series             | Security ball locking mechanism                             | ****         |              |                     | •         | ****     |
| Security series             | Safety applications   | ****         |              |                     | •         | ****     |
| Stainless steel series      | High security double ball locking mechanism                 | *****        |              |                     | •         | ****     |
| Stainless steel series      | Very serious corrosion condition                            | *****        |              |                     | •         | ****     |
| Changeable stainless series | Double security locking mechanism                           | *****        | •            |                     | •         | ****     |
| Changeable stainless series | Very serious corrosion condition                            | *****        | •            |                     | •         | ****     |
| Brass series                | Inox spring and varnished casing                            | ****         |              |                     | •         | ***      |
| Brass series                | Residential   | ****         |              |                     | •         | ***      |
| Changeable brass series     | Double security locking mechanism                           | ****         | •            |                     | •         | ****     |
| Changeable brass series     | Residential   | ****         | •            |                     | •         | ****     |
| Hermetic series             | Hytrel covering   | *****        |              |                     |           | ***      |
| Hermetic series             | Weatherproof  | *****        |              |                     |           | ***      |
| Combination series (chrome) | Double security locking mechanism (CPV50)                   | ****         |              |                     |           | ****     |
| Combination series (chrome) | Applications which require combination padlock              | ****         |              |                     |           | ****     |
| Combination series (brass)  | Brass combination   | ***          |              |                     |           | ***      |
| Combination series (brass)  | Applications which require combination padlock              | ***          |              |                     |           | ***      |

# Padlocks

## Brass series

- » Double security locking mechanism.
- » Hardened steel shackle.
- » Varnished brass casing for better protection.
- » Stainless steel springs.
- » Key alike.
- » Key to a certain number

| Reference  | Packaging | A  | B   | C  | D   |
|------------|-----------|----|-----|----|-----|
| CLV15LTK4  | Visual    | 15 | 31  | 10 | 2   |
| CL20LT     | In box    | 20 | 35  | 11 | 3   |
| CL20LTKA   | In box    | 20 | 35  | 11 | 3   |
| CL20LTKA   | In box    | 20 | 35  | 11 | 3   |
| CL2025LT   | In box    | 20 | 48  | 25 | 3   |
| CL2025LTKA | In box    | 20 | 48  | 25 | 3   |
| CL25LT     | In box    | 25 | 44  | 14 | 4   |
| CL25LTKA   | In box    | 25 | 44  | 14 | 4   |
| CL2530LT   | In box    | 25 | 60  | 30 | 4   |
| CL2530LTKA | In box    | 25 | 60  | 30 | 4   |
| CL30LT     | In box    | 30 | 50  | 18 | 5   |
| CL30LTKA   | In box    | 30 | 50  | 18 | 5   |
| CL3040LT   | In box    | 30 | 75  | 40 | 5   |
| CL3040LTKA | In box    | 30 | 75  | 40 | 5   |
| CL40LT     | In box    | 40 | 63  | 23 | 6   |
| CL40LTKA   | In box    | 40 | 63  | 23 | 6   |
| CL4055LT   | In box    | 40 | 95  | 55 | 6,5 |
| CL4055LTKA | In box    | 40 | 95  | 55 | 6,5 |
| CL50LT     | In box    | 50 | 78  | 29 | 8   |
| CL50LTKA   | In box    | 50 | 78  | 29 | 8   |
| CL5070LT   | In box    | 50 | 120 | 70 | 8   |
| CL5070LTKA | In box    | 50 | 120 | 70 | 8   |
| CL60LT     | In box    | 60 | 84  | 34 | 9   |
| CL60LTKA   | In box    | 60 | 84  | 34 | 9   |

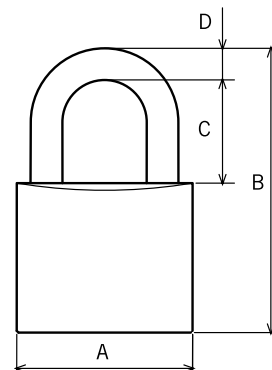

## Changeable brass series

- » Equipment with TESA cylinder system.
- » Double security locking mechanism.
- » Hardened steel shackle.
- » Varnished brass casing for better protection.
- » Possibility of keys alike and masterkeying.
- » Stainless steel springs.

| Reference  | Packaging | A  | B  | C  | D |
|------------|-----------|----|----|----|---|
| CL55SCIL   | In box    | 55 | 94 | 34 | 9 |
| CL55IPS    | In box    | 55 | 94 | 34 | 9 |
| CL55TE6LT  | In box    | 55 | 94 | 34 | 9 |
| CL55TX80LT | In box    | 55 | 94 | 34 | 9 |
| CL55T10LT  | In box    | 55 | 94 | 34 | 9 |
| CL55T12LT  | In box    | 55 | 94 | 34 | 9 |
| CL55T60LT  | In box    | 55 | 94 | 34 | 9 |
| CL55T80LT  | In box    | 55 | 94 | 34 | 9 |
| CL555030LT | In box    | 55 | 94 | 34 | 9 |



# Padlocks

## Stainless steel series

- » High security double ball locking mechanisms.
- » Stainless steel shackle.
- » Chrome brass casing with extraordinary resistance to corrosion.
- » Possibility of keys alike and key to a certain number.
- » Possibility of long shackle.
- » Stainless steel springs.

| Reference  | Packaging | A  | B   | C  | D |
|------------|-----------|----|-----|----|---|
| CL30CR     | In box    | 30 | 50  | 18 | 5 |
| CL30CRKA   | In box    | 30 | 50  | 18 | 5 |
| CL3040CR   | In box    | 30 | 75  | 40 | 5 |
| CL3040CRKA | In box    | 30 | 75  | 40 | 5 |
| CL40CR     | In box    | 40 | 63  | 23 | 6 |
| CL40CRKA   | In box    | 40 | 63  | 23 | 6 |
| CL4055CR   | In box    | 40 | 105 | 55 | 7 |
| CL4055CRKA | In box    | 40 | 105 | 55 | 7 |
| CL50CR     | In box    | 50 | 78  | 29 | 8 |
| CL50CRKA   | In box    | 50 | 78  | 29 | 8 |
| CL5070CR   | In box    | 50 | 120 | 70 | 9 |
| CL5070CRKA | In box    | 50 | 120 | 70 | 9 |



 Minimum lot  
Box of 10 pcs.

## Changeable stainless steel series

- » Double security locking mechanism.
- » Stainless steel shackle.
- » Chrome brass casing with extraordinary resistance to corrosion.
- » Possibility of keys alike and masterkeying.
- » Stainless steel springs.
- » Possibility of long shackle

| Reference    | Packaging | A  | B   | C  | D |
|--------------|-----------|----|-----|----|---|
| CL55CRSCIL   | In box    | 55 | 94  | 34 | 9 |
| CL55ALCRSCIL | In box    | 55 | 130 | 70 | 9 |
| CL55ALTE5CR  | In box    | 55 | 130 | 70 | 9 |
| CL55ALTE6CR  | In box    | 55 | 130 | 70 | 9 |
| CL55IPSCR    | In box    | 55 | 94  | 34 | 9 |
| CL55TE6CR    | In box    | 55 | 94  | 34 | 9 |
| CL55TK1V2CR  | In box    | 55 | 94  | 34 | 9 |
| CL55TX80CR   | In box    | 55 | 94  | 34 | 9 |
| CL55T10CR    | In box    | 55 | 94  | 34 | 9 |
| CL55T12CR    | In box    | 55 | 94  | 34 | 9 |
| CL55T60CR    | In box    | 55 | 94  | 34 | 9 |
| CL55T80CR    | In box    | 55 | 94  | 34 | 9 |
| CL555030CR   | In box    | 55 | 94  | 34 | 9 |

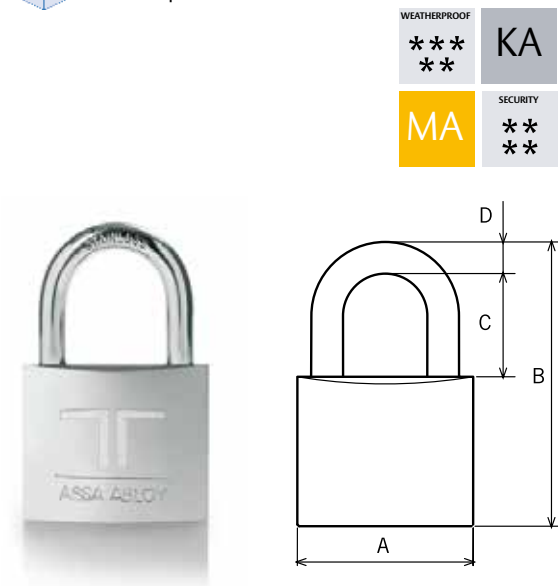

# Padlocks

## Hermetic series

- » Hermetic weatherproof padlock.
- » Highly resistant in adverse conditions.
- » Hytrel covering.
- » Stainless steel springs.
- » Double security locking mechanism.
- » Hardened steel shackle.
- » Brass casing

| Reference | Colour | A  | B  | C  | D |
|-----------|--------|----|----|----|---|
| CHV50A    | Blue   | 50 | 78 | 29 | 8 |
| CHV50R    | Red    | 50 | 78 | 29 | 8 |

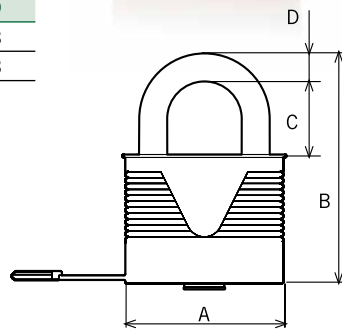
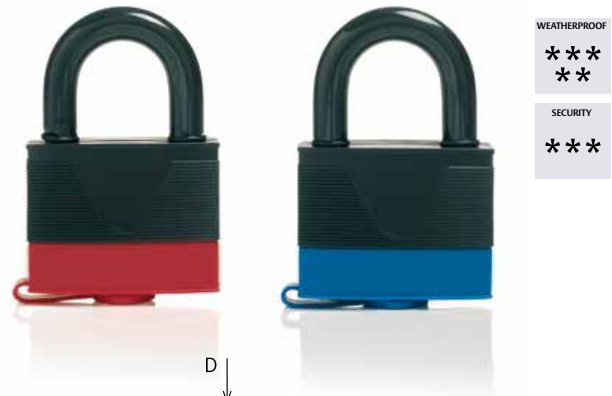

## Combination series

- » Programmable padlock.
- » Combination may be changed by the user themselves.
- » Stainless steel springs.
- » Coloured protection cover in CPV28.
- » Double security locking mechanism in CPV50.
- » Chrome brass casing with extraordinary resistance to corrosion.
- » Stainless steel shackle in CPV50.

| Reference | Packaging | A  | B  | C  | D |
|-----------|-----------|----|----|----|---|
| CPV50CR   | Visual    | 55 | 78 | 28 | 8 |
| CPV38LT   | Visual    | 38 | 85 | 30 | 6 |
| CPV28N    | Visual    | 24 | 58 | 23 | 3 |
| CPV28V    | Visual    | 24 | 58 | 23 | 3 |



CPV50CR

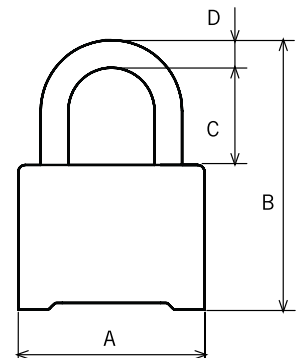

CPV28N



CPV28V

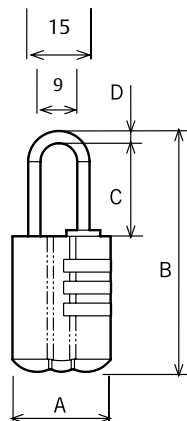

CPV38LT

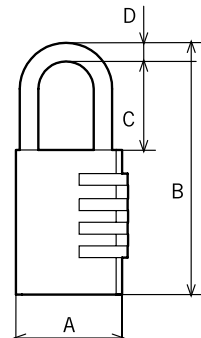

# Padlocks

## Security series

- » Security padlock.
- » Varnished brass casing for better protection.
- » Hardened chrome steel shackle with automatic opening.
- » Security ball locking mechanism.

| Reference | Packaging | A  | B  | C  | D  |
|-----------|-----------|----|----|----|----|
| CSCH70LT  | In box    | 70 | 48 | 14 | 12 |

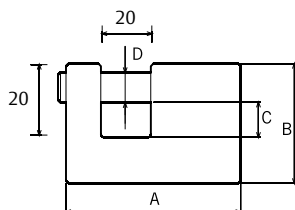

## High security series

- » High security padlock.
- » Standard or flat key cylinder.
- » Hardened chrome steel casing.
- » Major masterkeying possibilities.
- » Visual presentation.
- » Security ball locking mechanism.
- » Hardened chrome steel shackle.
- » Cylinder protection system.

| Reference | Packaging | A  | B  | C  | D  |
|-----------|-----------|----|----|----|----|
| CSIPS     | In box    | 90 | 80 | 18 | 12 |
| CSSCIL    | In box    | 90 | 80 | 18 | 12 |
| CSTE      | In box    | 90 | 80 | 18 | 12 |
| CSTX80    | In box    | 90 | 80 | 18 | 12 |
| CST10     | In box    | 90 | 80 | 18 | 12 |
| CST12     | In box    | 90 | 80 | 18 | 12 |
| CST60     | In box    | 90 | 80 | 18 | 12 |
| CST80     | In box    | 90 | 80 | 18 | 12 |

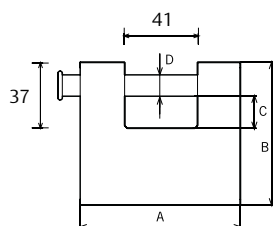
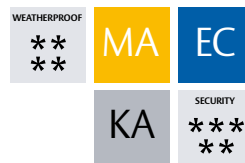



# Padlocks

## Titanium series

- » High security padlock.
- » High resistance double security ball locking mechanism.
- » All types of masterkeying.
- » Hardened chrome steel casing and shackle.
- » Hytrel protective covering.
- » Cylinder protection system.
- » Non-removable key with open padlock.
- » Anti-guillotine, anti-lever model CT60APCR model and anti-extraction.
- » Maximum security reversible key cylinders.

| Reference   | Packaging | A  | B  | C  | D  |
|-------------|-----------|----|----|----|----|
| CT60SCIL    | In box    | 60 | 93 | 23 | 11 |
| CT60TK1V2CR | In box    | 60 | 93 | 23 | 11 |
| CT60TX80CR  | In box    | 60 | 93 | 23 | 11 |
| CT60T10CR   | In box    | 60 | 93 | 23 | 11 |
| CT60T12CR   | In box    | 60 | 93 | 23 | 11 |
| CT60T60CR   | In box    | 60 | 93 | 23 | 11 |
| CT60T80CR   | In box    | 60 | 93 | 23 | 11 |

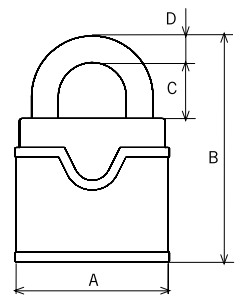

## Titanium series, protected shackle

| Reference     | Packaging | A  | B  | C  | D  |
|---------------|-----------|----|----|----|----|
| CT60APT60CR   | In box    | 60 | 93 | 23 | 11 |
| CT60APT80CR   | In box    | 60 | 93 | 23 | 11 |
| CT60APT80CR   | In box    | 60 | 93 | 23 | 11 |
| CT60APTK1V2CR | In box    | 60 | 93 | 23 | 11 |
| CT60APT10CR   | In box    | 60 | 93 | 23 | 11 |
| CT60APT12CR   | In box    | 60 | 93 | 23 | 11 |

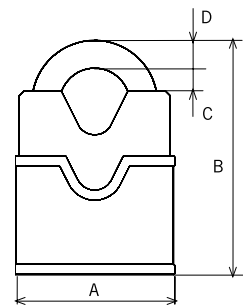

## Titanium stainless steel series

- » High security padlock.
- » High resistance double security ball locking mechanism.
- » All types of masterkeying.
- » Stainless steel casing and shackle.
- » Hytrel protective covering.
- » Cylinder protection system.
- » Non-removable key with open padlock.
- » Maximum security reversible key cylinders.

| Reference   | Packaging | A  | B  | C  | D  |
|-------------|-----------|----|----|----|----|
| CT60TK1V2IS | In box    | 60 | 93 | 23 | 11 |
| CT60TX80IS  | In box    | 60 | 93 | 23 | 11 |
| CT60T12IS   | In box    | 60 | 93 | 23 | 11 |
| CT60T60IS   | In box    | 60 | 93 | 23 | 11 |
| CT60T80IS   | In box    | 60 | 93 | 23 | 11 |





---

**ASSA ABLOY**

Talleres de Escoriaza, S.A.U.  
Barrio Ventas, 35 • E-20305 Irun • SPAIN  
Tel.: +34 943 669 100 • Fax: +34 943 633 221  
[www.tesa.es](http://www.tesa.es)

ASSA ABLOY is the global leader in door opening solutions,  
dedicated to satisfying end-user needs for security, safety and convenience